

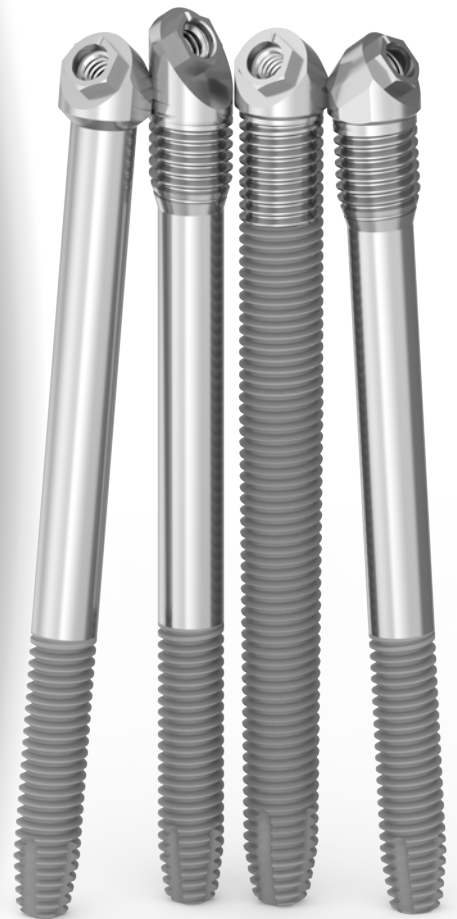

SOUTHERNIMPLANTS®

Innovative Treatment Solutions

ZYGOMATIC Implants
Product Catalogue





Southern Implants® is a leading provider of unique and innovative dental implant products with a focus on top-end professional users who want more choices. Southern's expertise in research, development and manufacturing of dental implants allows us to provide Innovative Treatment Solutions that will reduce treatment times and improve patient outcomes.

Striving for excellence and meeting customer needs, has led to our wide product range characterised by Unique and Innovative products which include:

- Multiple interfaces, to suit customer preference.
- INVERTA® implant, featuring a Body-Shift™ design, engineered for primary stability and suitable for immediate loading.
- Co-Axis®, Subcrestal Angle Correction® implants, available in angulations of 12°, 24° and 36° and various internal and external connections.
- MAX implant, specifically designed for immediate molar tooth replacement.
- The ZYGAN®, ZYGEX and ZYGIN implants for severely resorbed maxilla and craniofacial reconstruction.

Our product portfolio is in synchronised evolution with protocol improvements and technological advances.

My sincere thanks to all specialists, dentists and technicians who put their trust in our company.

Graham Blackbeard
Managing Director, Southern Implants

CONTENTS

Zygomatic and ZYGAN® Implants	
Implants and Surgical Components.....	Page 06
Prosthetic Flowchart (direct).....	Page 07
Prosthetic Flowchart (indirect).....	Page 08
Site Preparation Sequences.....	Page 09
ZYGIN Implants	
Implants and Surgical Components.....	Page 12
Prosthetic Flowchart (indirect).....	Page 13
Site Preparation Sequences.....	Page 14
Oncology and ZYGEX Implants	
Implants and Surgical Components.....	Page 16
Prosthetic Flowchart (direct).....	Page 17
Prosthetic Flowchart (indirect).....	Page 18
Site Preparation Sequences.....	Page 19
Zygomatic Guided Surgery Drills.....	Page 21
Drill Information.....	Page 22
Torque Table for Southern Screws.....	Page 24
Zygomatic Protocol Synopsis.....	Page 25
Implant Dimensions and Information.....	Page 26
Instruments for implants packaged with a fixture mount.....	Page 27
Instrument Trays	
I-ZYG-1.....	Page 28
I-PROS-EG.....	Page 30
Explanation of Symbols.....	Page 31
Platform Interface.....	Page 31

For more information scan the below



or visit

SOUTHERNIMPLANTS.COM

NOTE:

- images are for illustration purposes only and do not necessarily accurately represent the product.
- all dimensions in this catalogue are in mm, unless otherwise specified.
- not all products are cleared for sale in all countries.

ZYGOMATIC
ZYGAN®

ZYGOMATIC and ZYGAN® Implants

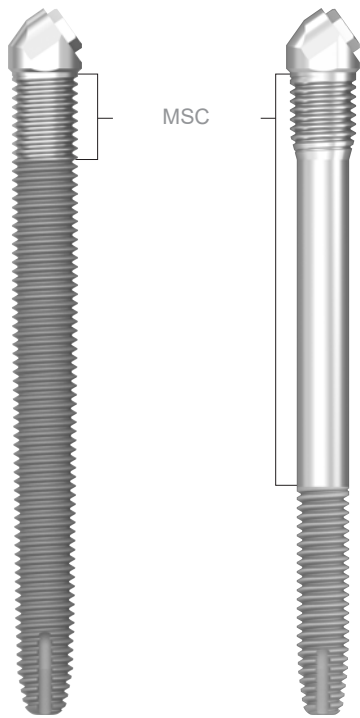

ZYG-55-xx

ZYGAN-xx



(where xx is implant length)

NOTE:

- implant dimensions and information - page 22.
- all ZYG and ZYGAN® implants are packaged with a Bone Mill fixture mount. For more information refer to CAT-1219.

Implants are premounted and available in lengths of:

ITEM CODE	IMPLANT LENGTH CODES (in mm)
ZYG-55-	35N / 37.5N / 40N / 42.5N / 45N / 47.5N / 50N / 52.5N / 55N / 60N
ZYGAN-	30 / 32.5 / 35 / 37.5 / 40 / 42.5 / 45 / 47.5 / 50 / 52.5 / 55 / 57.5 / 60

Surgical Components

Cover Screw

SCU2



Healing Abutments

TBx

Ø4.5



2/3/4/5/6/8 lengths

WBx

Ø5.5



2/3/4/6/8 lengths

(where x is length)

INDIRECT

Compact Conical Abutment

Healing Caps

Impression Copings

Laboratory Analogues

Prosthetic Components

Retaining Screws

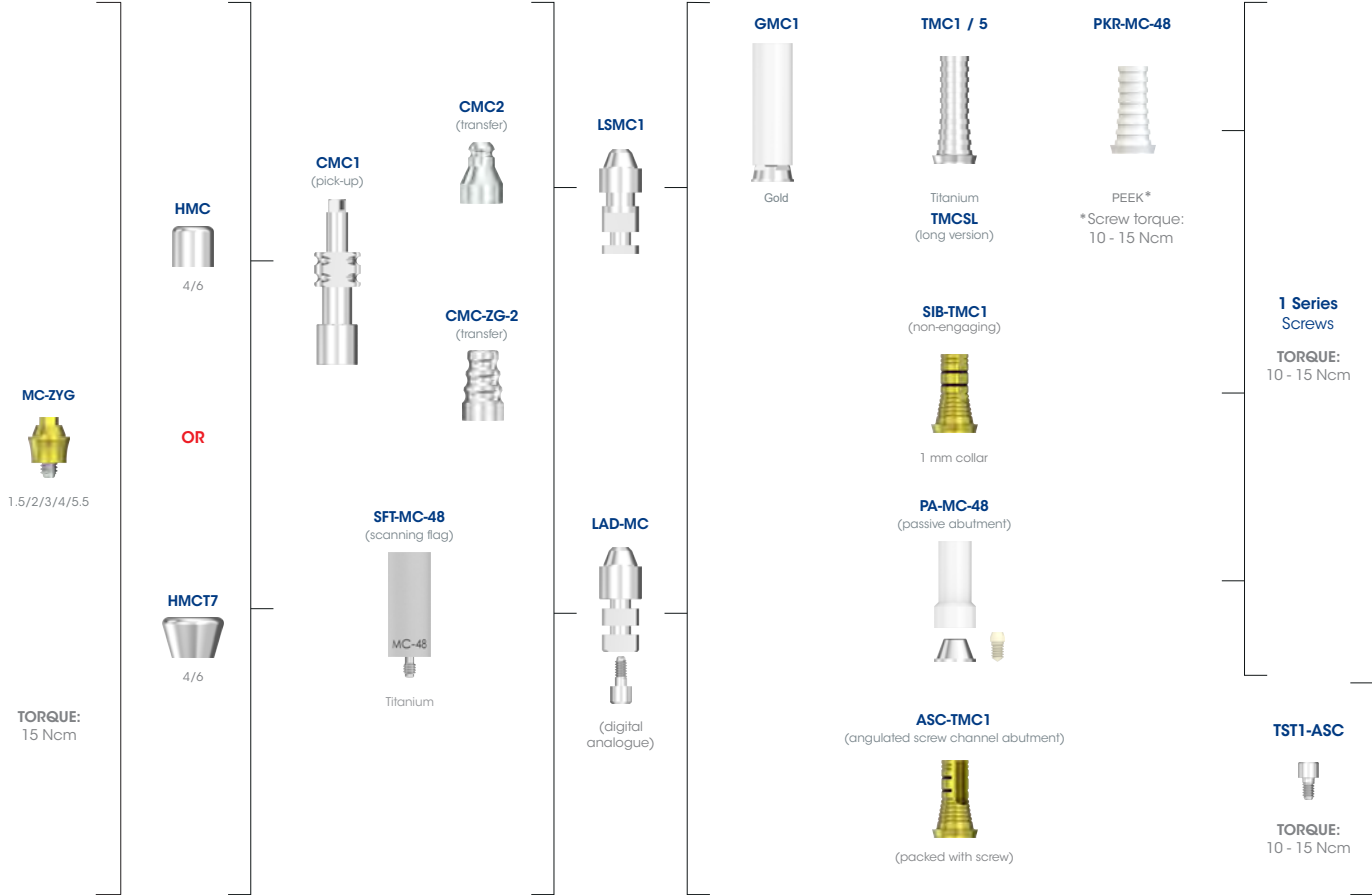

NOTE:

- for optimal coronal hard and soft tissue health, it is strongly recommended that all Southern Zygomatic implants are restored with compact conical abutments (indirect route).
- the direct route is only recommended if there are restorative considerations that preclude the use of compact conical abutments.

Direct

Healing Abutments



Impression Copings



Laboratory Analogues



Prosthetic Components

GC-EX-40 (engaging)
GC-NX-40 (non-engaging)



Gold

TC-EX-40-C1 (engaging)
TC-NX-40-C1 (non-engaging)



Titanium

TC-EX-40-C5 (engaging)
TC-NX-40-C5 (non-engaging)



Titanium

PKR-EX-40 (engaging)
PKR-NX-40 (non-engaging)



PEEK*

*Screw torque: 20 Ncm

SIB-EX-40-50C1.5 (engaging)
SIB-NX-40-50C1.5 (non-engaging)



Ø5.0 platform
1.5 mm collar

SIB-EX-40-50C3 (engaging)
SIB-NX-40-50C3 (non-engaging)



Ø5.0 platform
3 mm collar

SIB-EX-40-55C3 (engaging)
SIB-NX-40-55C3 (non-engaging)



Ø5.5 platform
3 mm collar

SIB-EX-40-55C5 (engaging)
SIB-NX-40-55C5 (non-engaging)



Ø5.5 platform
5 mm collar

TIB-EX-40 (engaging)
TIB-NX-40 (non-engaging)



TIB-EX-40-C1.5 (engaging)
TIB-NX-40-C1.5 (non-engaging)



TIB-EX-40-C3 (engaging)
TIB-NX-40-C3 (non-engaging)



CIA-EX-40 (engaging)
CIA-NX-40 (non-engaging)



TIB abutments available in 3 cuff height variants:
0.6 mm, 1.5 mm and 3 mm

PASSIVE Abutment

Angulated Screw Channel Abutment

SB16 (engaging)
SB-17-T (non-engaging)



ASC-EX-40



(packed with screw)

Retaining Screws

3 Series Screws

TORQUE: 32 - 40 Ncm

2 Series Screws

TORQUE: 32 - 40 Ncm

ASC Abutment Screw

TSTZ5-ASC



Titanium

Torque 32 - 40 Ncm

Sinus-slot or in-the-wall technique

(illustrations are for 42.5 mm Zygomatic implants)

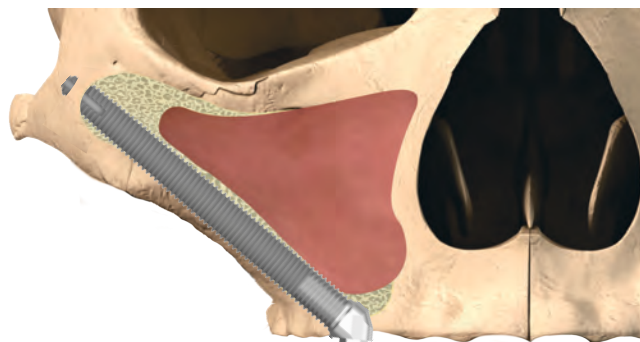

D-3SPADE-ZYG

D-ZYG-27S

D-ZYG-29S

D-ZYG-CS-S
(optional for hard bone)

D-ZYG-35S

Exteriorised technique (in-out-in)

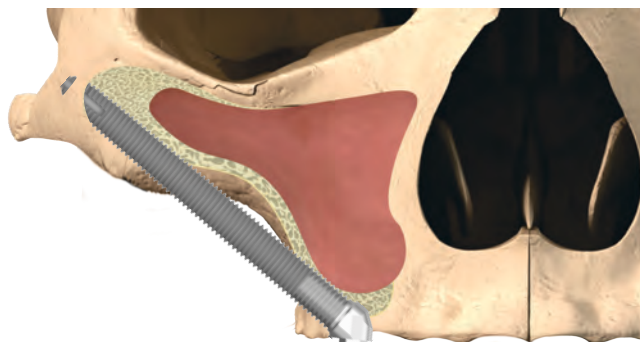

D-3SPADE-ZYG

D-ZYG-27S

D-ZYG-29S

D-ZYG-CS-S
(optional for hard bone)

D-ZYG-35S

NOTE: site preparation sequence recommended by Southern Implants does not replace the judgement and experience of the surgeon.

Sinus-slot or in-the-wall technique

(illustrations are for 42.5 mm ZYGAN® implants)

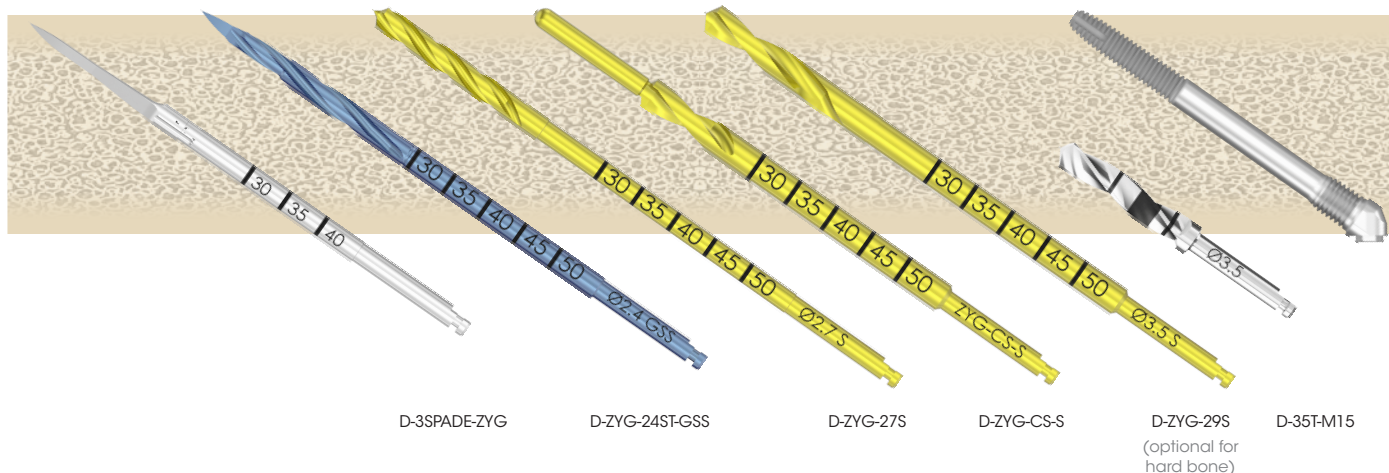
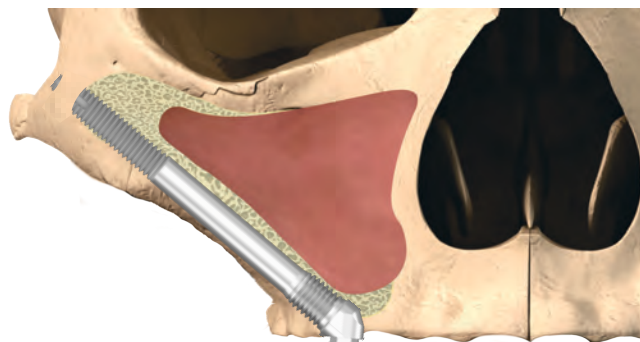

Exteriorised technique (in-out-in)

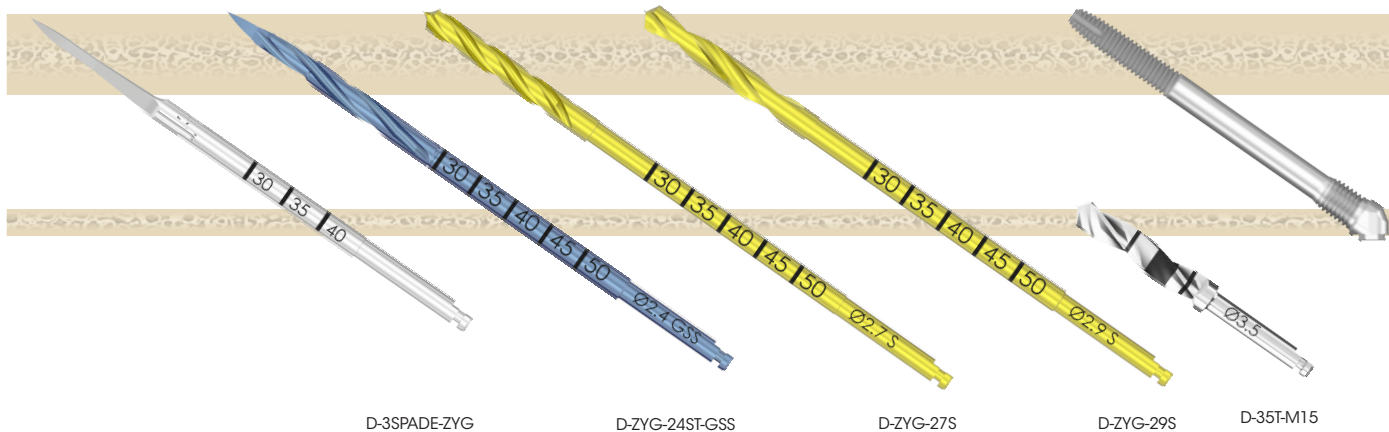
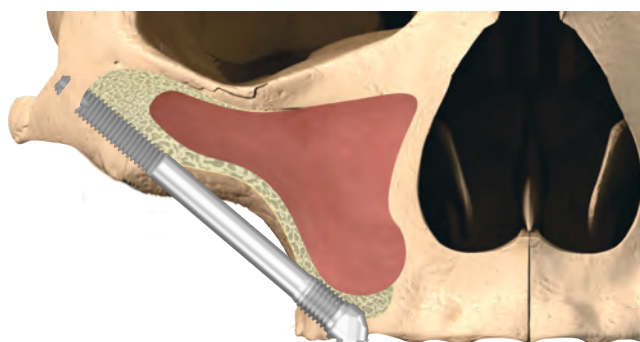

NOTE: site preparation sequence recommended by Southern Implants does not replace the judgement and experience of the surgeon.

ZYGIN Implants

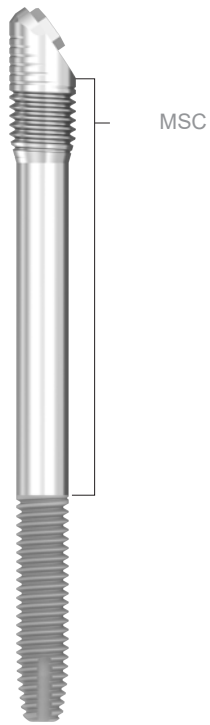

ZYGIN-xx

(where xx is implant length)

Implants are premounted and available in lengths of:

NOTE: implant dimensions and information - page 22.

ITEM CODE	IMPLANT LENGTH CODES (in mm)
ZYGIN-	30 / 32.5 / 35 / 37.5 / 40 / 42.5 / 45 / 47.5 / 50 / 52.5 / 55 / 57.5 / 60

Surgical Components

(where x is length)

Cover Screw

CS-ZYG

Healing Abutments

N/A



INDIRECT

Compact Conical Abutment

Healing Caps

Impression Copings

Laboratory Analogues

Prosthetic Components

Retaining Screws

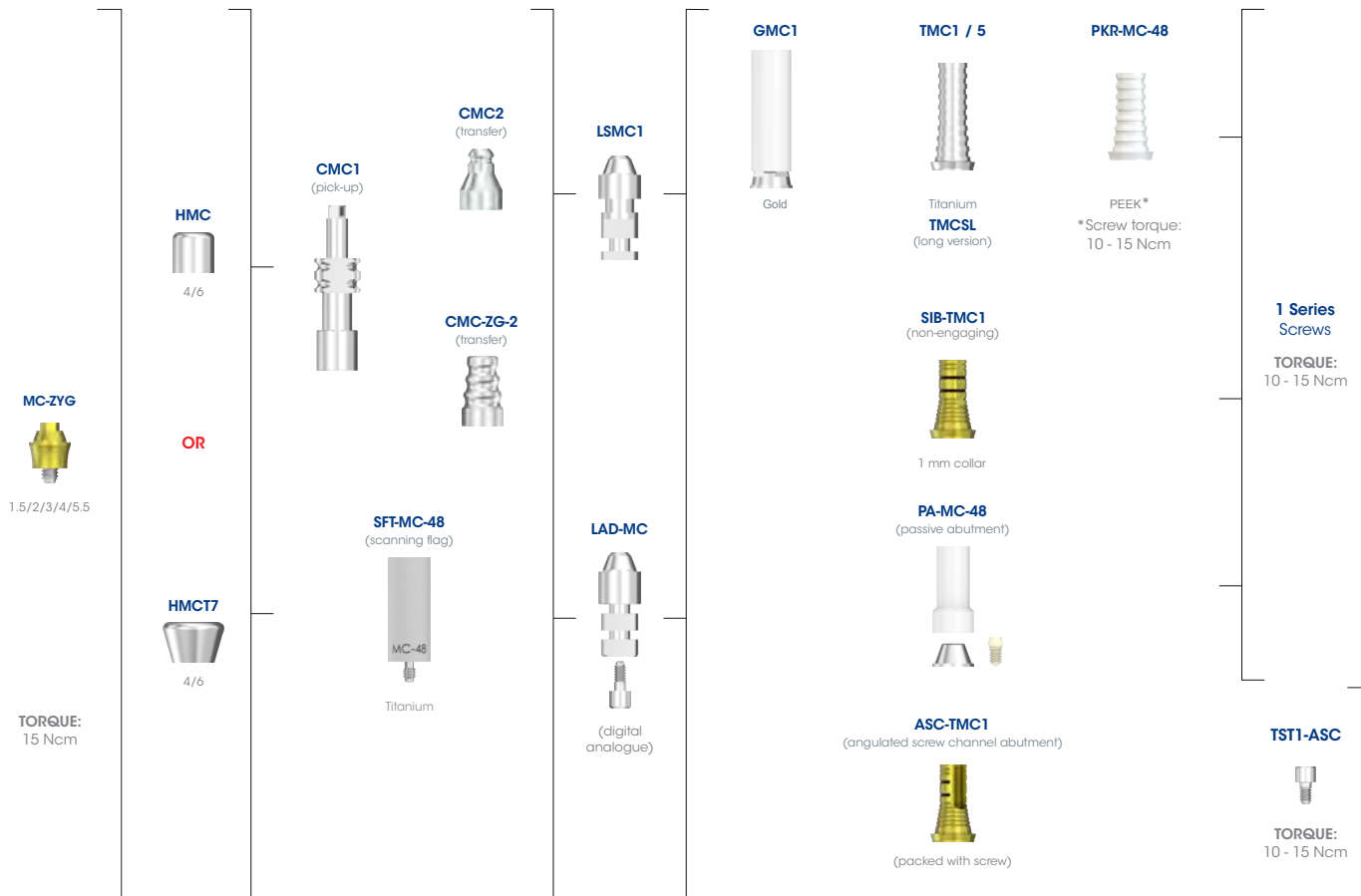

NOTE:

- for optimal coronal hard and soft tissue health, it is strongly recommended that all Southern Zygomatic implants are restored with compact conical abutments (indirect route).
- the direct route is only recommended if there are restorative considerations that preclude the use of compact conical abutments.

Sinus-slot or in-the-wall technique

(illustrations are for 42.5 mm ZYGIN implants)

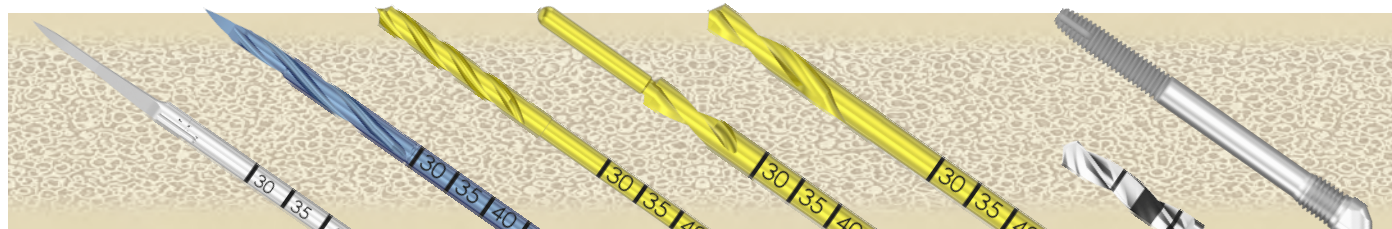
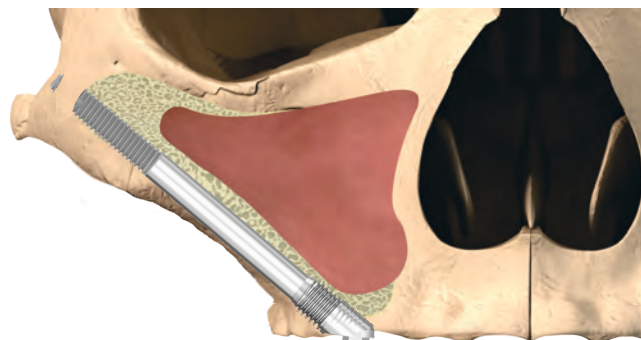

D-3SPADE-ZYG D-ZYG-24ST-GSS D-ZYG-27S D-ZYG-CS-S D-ZYG-29S (optional for hard bone) D-35T-M15

Exteriorised technique (in-out-in)

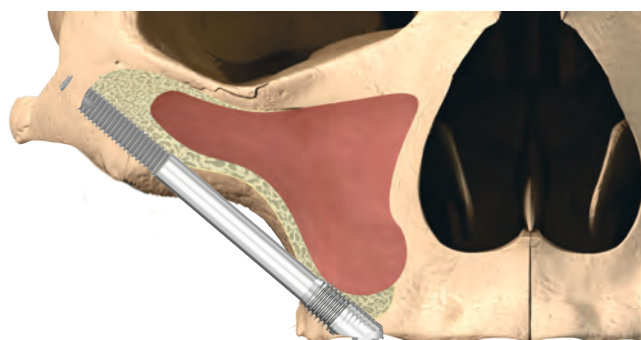

D-3SPADE-ZYG D-ZYG-24ST-GSS D-ZYG-27S D-ZYG-29S D-35T-M15

NOTE: site preparation sequence recommended by Southern Implants does not replace the judgement and experience of the surgeon.

ONCOLOGY
ZYGEX



ONC-55



ZYGEX

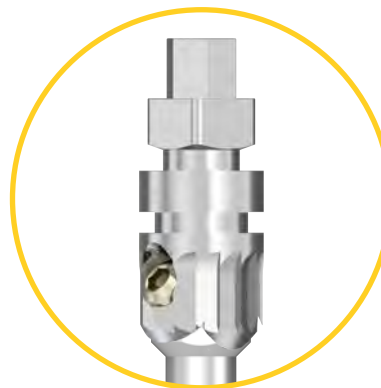

(where xx is implant length)

- NOTE:**
- implant dimensions and information - page 22.
 - all ZYGEX implants are packaged with a Bone Mill fixture mount. For more information refer to CAT-1219.

Implants are premounted and available in lengths of:

ITEM CODE	IMPLANT LENGTH CODES (in mm)
ONC-55-	27.5N / 32.5N / 37.5N / 42.5N / 47.5N
ZYGEX-	30 / 32.5 / 35 / 37.5 / 40 / 42.5 / 45 / 47.5 / 50 / 52.5 / 55 / 57.5 / 60

Surgical Components

Cover Screw

SCU2



Healing Abutments

TBx

Ø4.5



2/3/4/5/6/8 lengths

WBx

Ø5.5



2/3/4/6/8 lengths

(where x is length)

INDIRECT

Compact Conical Abutment

Healing Caps

Impression Copings

Laboratory Analogues

Prosthetic Components

Retaining Screws

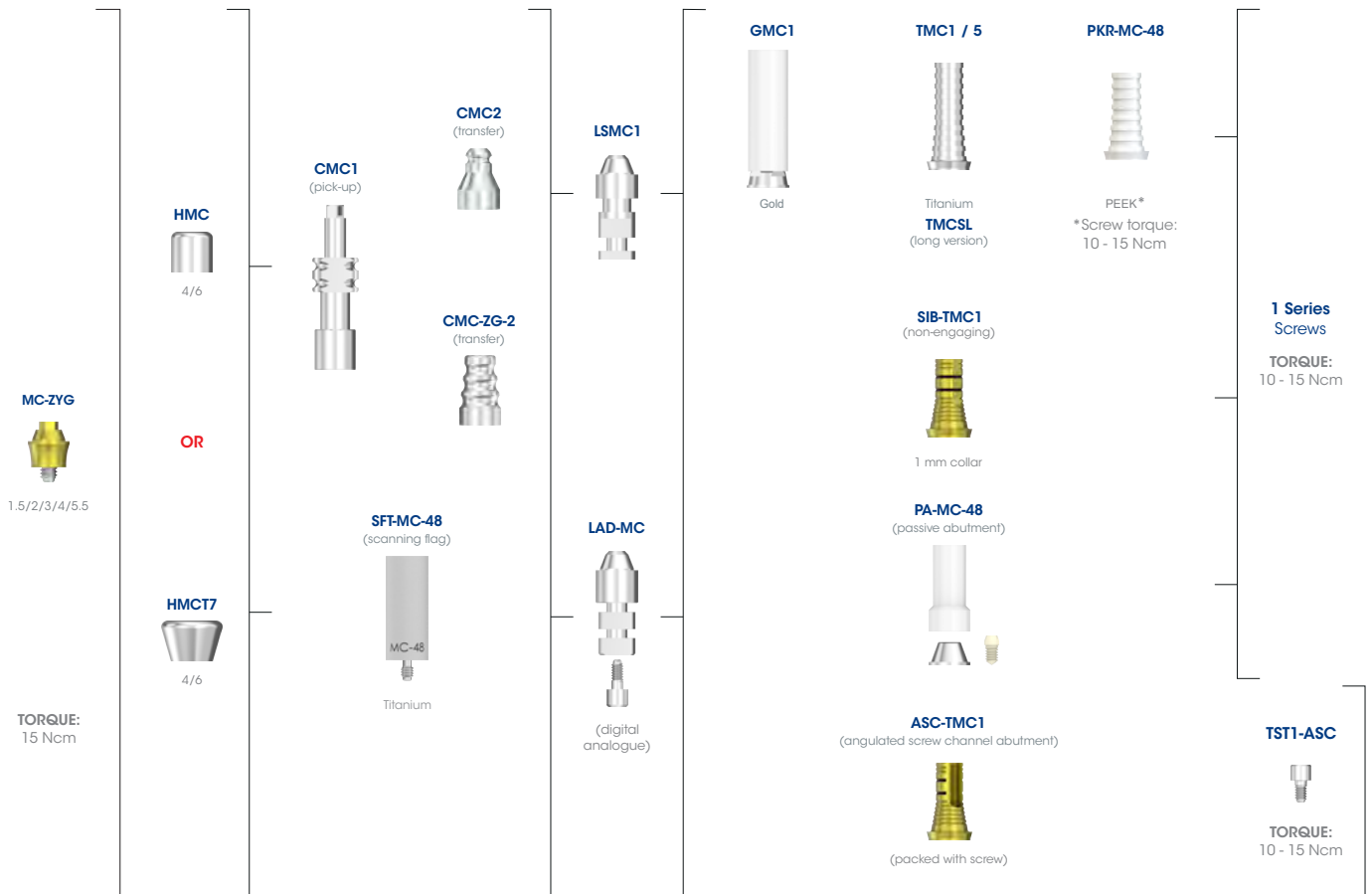

NOTE:

- for optimal coronal hard and soft tissue health, it is strongly recommended that all Southern Zygomatic implants are restored with compact conical abutments (indirect route).
- the direct route is only recommended if there are restorative considerations that preclude the use of compact conical abutments.

Direct

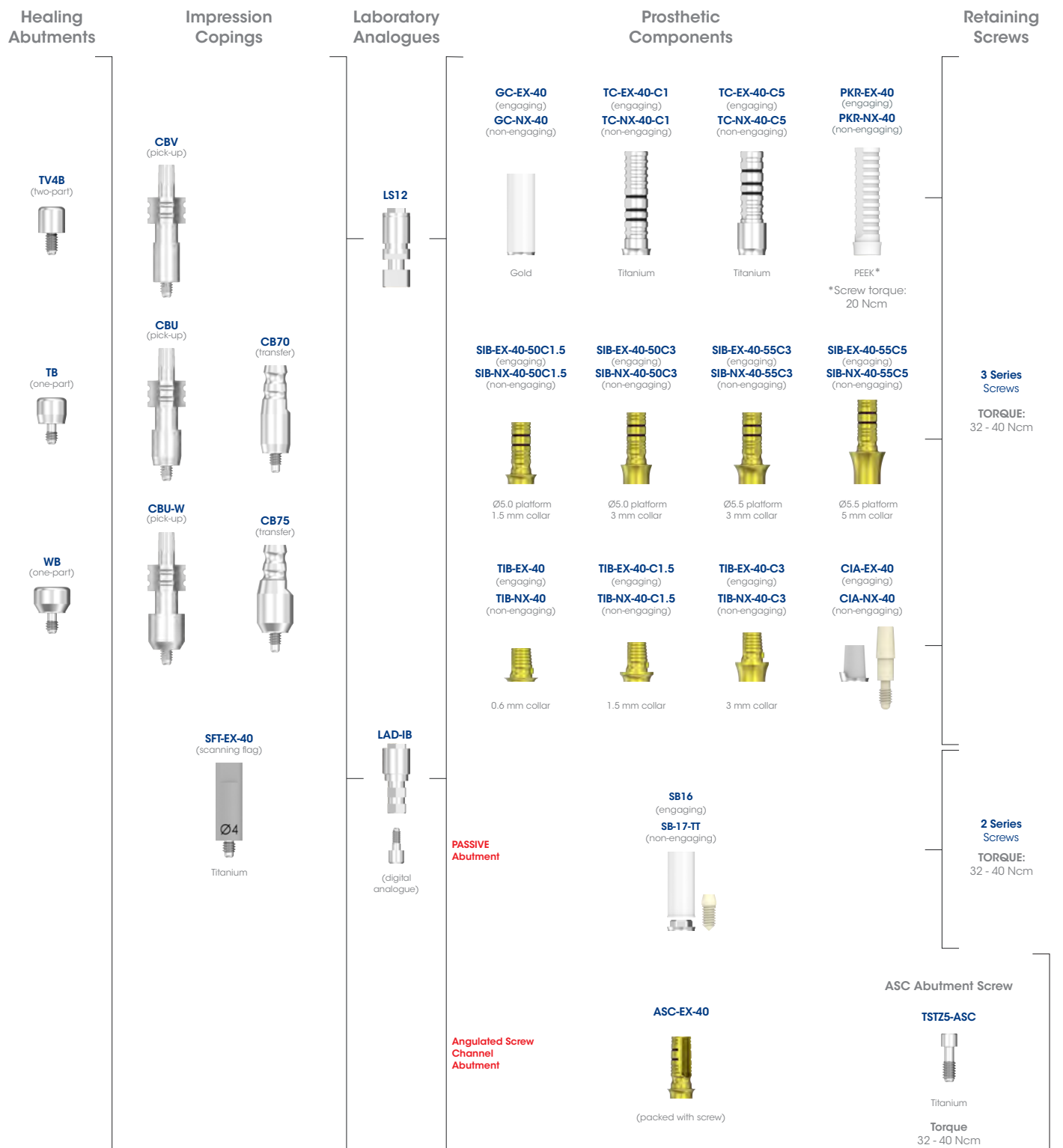

Maxillectomy

(illustration is for 42.5 mm ONC implant)

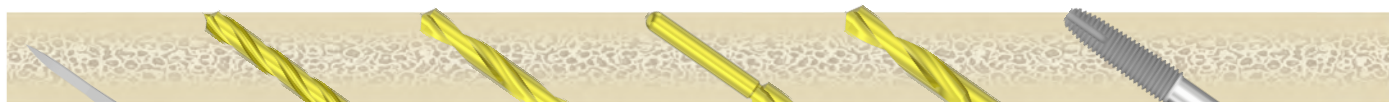
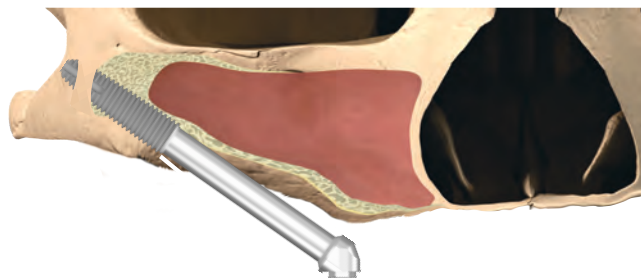

D-3SPADE-ZYG

D-ZYG-27S

D-ZYG-29S

D-ZYG-CS-S
(optional for hard bone)

D-ZYG-35S

NOTE: site preparation sequence recommended by Southern Implants does not replace the judgement and experience of the surgeon.

Exteriorised technique

(illustrations are for 42.5 mm ZYGEX implants)

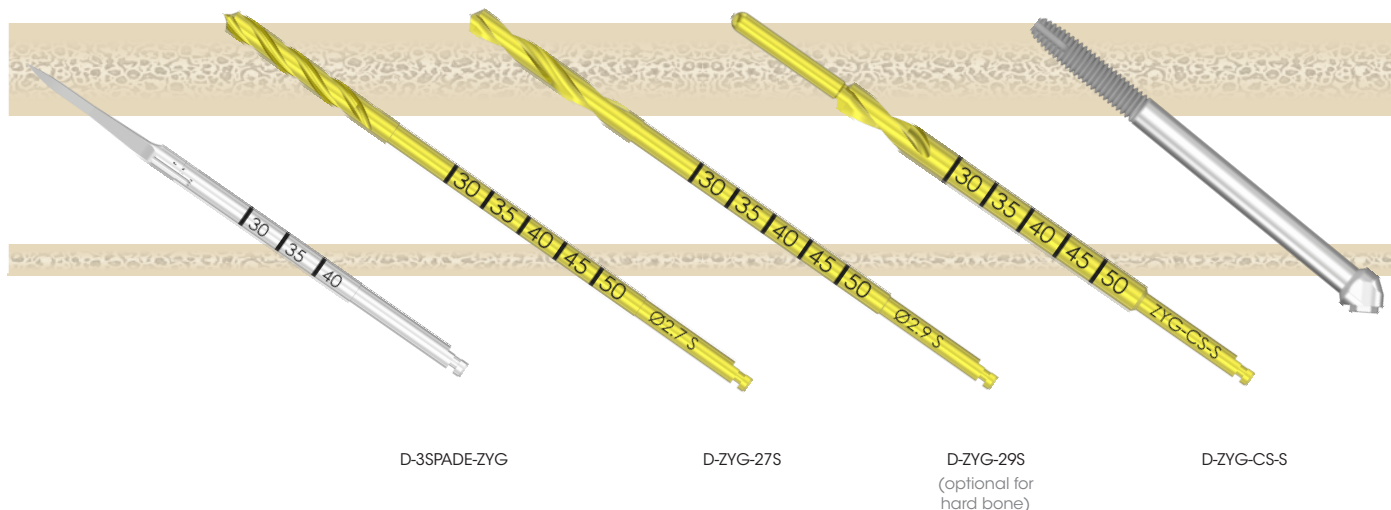
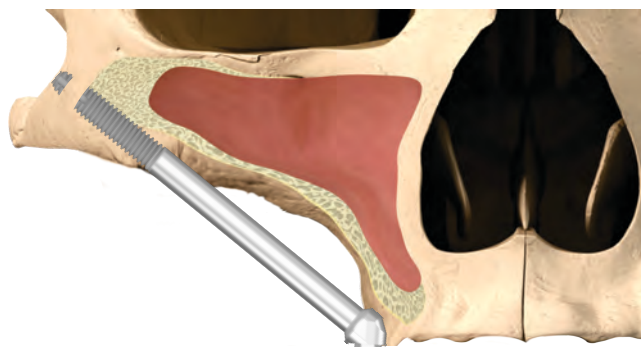

Maxillectomy

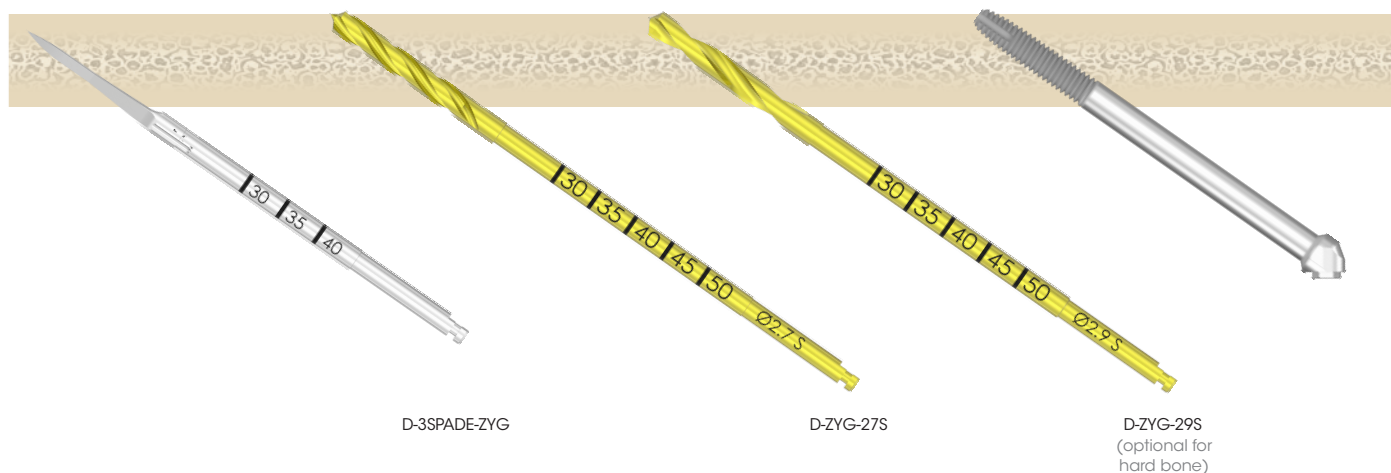
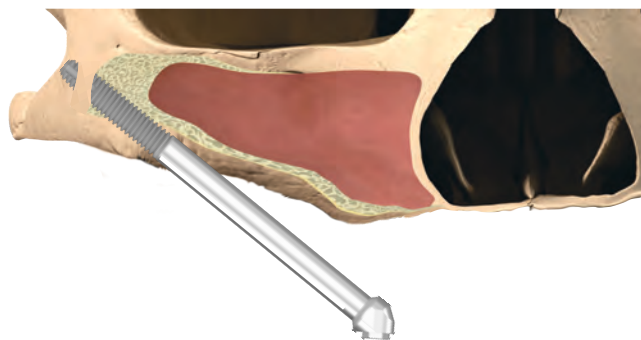

NOTE: site preparation sequence recommended by Southern Implants does not replace the judgement and experience of the surgeon.

Zygomatic Guided Surgery Drills

The Zygomatic implant range may be placed utilising the guided surgery drills (D-ZYG-24ST-GSS/M/L and D-ZYG-27ST-GSM/L), which **initiate the osteotomy and create a Ø2.4 mm or Ø2.7 mm site at the same time.**

Clinicians are able to either place the implant following the Ø2.4 mm or Ø2.7 mm drill (depending on the bone density) or can continue prepping the osteotomy site as per the recommended drilling protocol.

NOTE: the drill is intended for angulation guidance and has no physical stop for depth control. Depth control is still determined by the patient's anatomy and the judgement and experience of the surgeon.

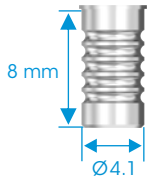

I-GSZ-4128-L8 Ø4.1 mm x 8 mm long
Guided Surgery Sleeve - Zygomatic

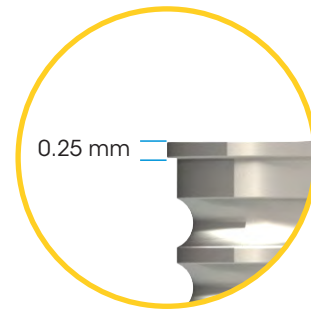

NOTE:

- the lip on the guide sleeve, adds 0.25 mm, this does not need to be taken into consideration as most Southern Implants drills extend 1 mm longer.
- **always plan for at least 2 mm from nerves / anatomical structures.**

Ø2.4 mm Zygomatic Spade Drills			Ø2.7 mm Zygomatic Spade Drills	
D-ZYG-24ST-GSS	D-ZYG-24ST-GSM	D-ZYG-24ST-GSL	D-ZYG-27ST-GSM	D-ZYG-27ST-GSL
(short)	(medium)	(long)	(medium)	(long)



DRILL INFORMATION

Pilot Drills	Ø2.4 mm	Ø2.7 mm
D-3SPADE-ZYG	D-ZYG-24ST-GSS	D-ZYG-27
D-ZYG-RB	D-ZYG-24ST-GSM	D-ZYG-27S
	D-ZYG-24ST-GSL	D-ZYG-CH-27
		D-ZYG-CH-27S
		D-ZYG-27ST-GSL
		D-ZYG-27ST-GSM

DRILL MARKINGS

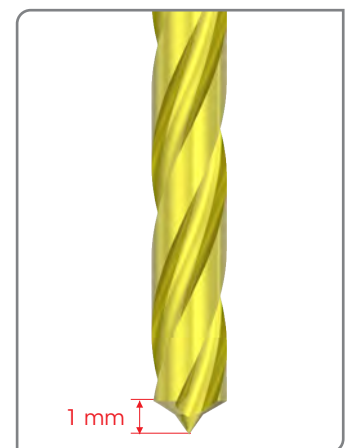
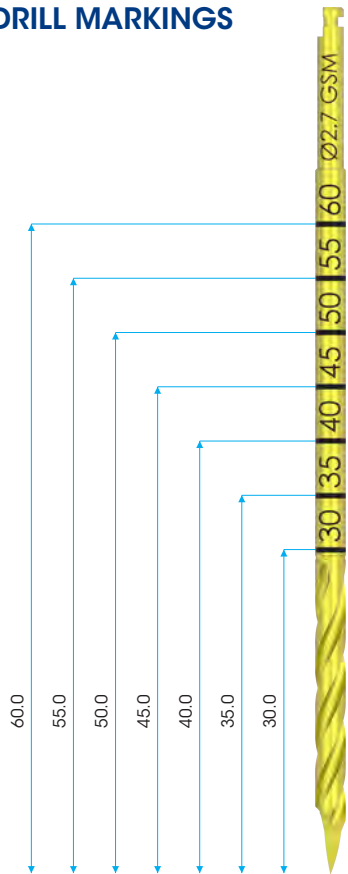

CAUTION: when drilling close to crucial anatomical landmarks, consider that the drill preparation site may be up to 1 mm deeper than the corresponding implant length.

DRILL INFORMATION

Ø2.9 mm				Ø3.5 mm			Counter-Sink (Ø3.4 mm)	Side Cutting	
D-ZYG-29	D-ZYG-29S	D-ZYG-CH-29	D-ZYG-CH-29S	D-ZYG-35	D-ZYG-35S	D-35TM15	D-ZYG-CS	D-ZYG-CS-S	CH-D-CM

TORQUE TABLE FOR SOUTHERN SCREWS

1 Series screws (M1.4)

1.22 Hex



TSH1



GSH1



BSH1*

Slotted



TSS1



GSS1



BSS1*

Unigrip



TSU1



GSU1

TORQUE:
10 - 15 Ncm
Head diameter:
2.25 mm
Screw TORQUE with
PEEK Prosthetics:
10 - 15 Ncm

2 Series screws (M2)

1.22 Hex



TSHZ2



BSH2*

Quad



GSQZ2

Slotted



TSSZ2



GSSZ2



BSSZ2*

Unigrip



TSUZ2



GSUZ2

TORQUE:
32 - 40 Ncm
Head diameter:
2.70 mm

3 Series screws (M2)

1.22 Hex



TSHZ3



BSH3*

Quad



GSQZ3

Slotted



TSSZ3



GSSZ3



BSSZ3*

Unigrip



TSUZ3



GSUZ3

TORQUE:
32 - 40 Ncm
Head diameter:
2.40 mm

NOTE: screw TORQUE with PEEK Prosthetics:
< Ø4.0 mm implant interfaces: 15 Ncm
≥ Ø4.0 mm implant interfaces: 20 Ncm

ASC 1 Series screw



TST1-ASC

TORQUE:
10 - 15 Ncm
Head diameter:
2.20 mm

Screw product codes

Southern screws are manufactured from different materials.
This is indicated with the first letter of the product code:

- T** = Titanium
- G** = Gold
- B** = Brass

Digital Laboratory Analogue screw

1.22 Hex



LAD-S

TORQUE:
Finger tighten
Head diameter:
2.40 mm

NOTE:

- due to design revisions and changes, screw tips may be flat or rounded.
- always ensure that the correct screw is used for the relevant implant and component.
- * blackened and for laboratory use only.
- universal drivers are compatible with both 1.22 and 1.27 Hex screws:
 - I-HD22U-S/M/L
 - I-HHD-22U-S/M/L
 - I-WI-22U-S/M/L

Screw supplied with all Digital Analogues.

Screw Head Connections

Hex



Slotted



Unigrip



Quad



ASC



Zygomatic Protocol Synopsis

Southern Implants® is aware of a number of different protocols currently used by various centres around the world. The classic technique for zygomatic placement involved cutting a sinus window and placing the implant through the sinus. The sinus-slot technique and exteriorised technique have since been developed, with the implant placed through the sinus wall and outside the sinus wall respectively. It has been suggested that the choice of technique should consider the ridge crest concavity and sinus anatomy (Chrcanovic et al. 2013). The ZAGA approach classifies the anatomy into different types to determine the appropriate technique for Zygomatic implant placement (Aparicio et al. 2014).

While the chosen placement technique and implant choice is up to the practitioner's preference, this section illustrates the best Southern Implants Zygomatic implant for each technique using the ZAGA approach.

Anatomy	ZAGA classification	Implant path	Alternate placement technique	ZYG-55	ZYGAN®	ZYGIN	ZYGEX	ONC-55
Anterior maxillary wall is very flat	ZAGA 0	Intra-sinus	Classic	✓	✓	✓		
Anterior maxillary wall is slightly concave	ZAGA 1	Intra-extra path	Classic/sinus-slot	✓	✓	✓		
Anterior maxillary wall is concave	ZAGA 2	Extra-intra path	Sinus-slot/exteriorized	✓	✓	✓		
Anterior maxillary wall is very concave	ZAGA 3	Extra-sinus	Exteriorized		✓	✓	✓	✓
Maxilla and alveolar bone show extreme atrophy or maxilla has been resected	ZAGA 4	Extra-maxillary	Extra-alveolar				✓	✓

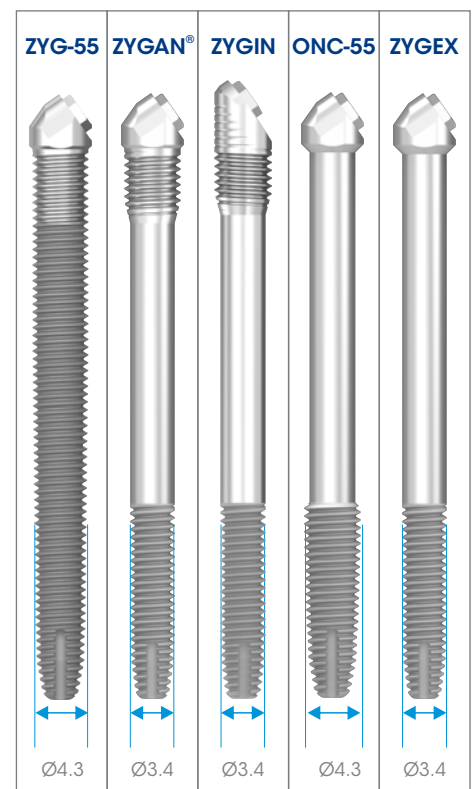

The quad protocol is placing two implants in one zygoma. The ZYGAN®, ZYGIN and ZYGEX are best suited to the quad protocol due to their narrower apex.

The MSC Zygomatic implant (ZYG-55, ZYGIN and ZYGAN®) also captures the advantage of a specific roughness machined coronal surface area that covers the 6 mm crestal portion of the implant. Indicated for patients with higher risk of coronal bone loss (smokers, history of periodontitis and cardiovascular disease).

The new ZYG Bone Mill Fixture Mount aims to provide a multipurpose function where it performs as both the fixture mount required for insertion as well as a bone mill to prepare the alveolar bone for abutment seating. The 'Bone Mill Fixture Mount' is designed with cutting edges which engage the alveolar bone at time of insertion. For more information regarding the Bone Mill Fixture Mount, refer to CAT-1219.

The new ZYGIN implant is equipped with a narrower Fixture Mount and implant head. Indicated for patients with severe atrophy of the alveolar ridge.

References:

- Chrcanovic BR, Abreu MHNG. Survival and complications of zygomatic implants: a systematic review. Oral Maxillofac Surg. 2013 Jun;17(2):81-93.
- Aparicio C, Manresa C, Francisco K, Aparicio A, Nunes J, Claros P, et al. Zygomatic implants placed using the zygomatic anatomy-guided approach versus the classical technique: a proposed system to report rhinosinusitis diagnosis. Clin Implant Dent Relat Res. 2014 Oct;16(5):627-42.

IMPLANT DIMENSIONS AND INFORMATION

RANGE	THREADED CORONAL DIAMETER	MACHINED BODY DIAMETER	PROSTHETIC PLATFORM	ZYGOMA THREAD DIAMETER	HEX WIDTH	HEX HEIGHT	THREAD LENGTH	THREAD PITCH	APEX DIAMETER	PLATFORM or HEAD ANGLE	IMPLANT LENGTHS																	
											27.5	30	32.5	35	37.5	40	42.5	45	47.5	50	52.5	55	57.5	60				
ZYG-55	4.3	N/A	4.0	4.3	2.70	0.7	Full	0.6	3.0	55°					✓	✓	✓	✓	✓	✓	✓	✓	✓	✓	✓	✓	✓	
ZYGAN®	4.3	3.4	4.0	3.4	2.70	0.7	15	0.6	2.8	55°		✓	✓	✓	✓	✓	✓	✓	✓	✓	✓	✓	✓	✓	✓	✓	✓	✓
ZYGIN	4.3	3.4	4.0	3.4	2.70	0.7	15	0.6	2.8	55°		✓	✓	✓	✓	✓	✓	✓	✓	✓	✓	✓	✓	✓	✓	✓	✓	✓
ONC-55	N/A	3.5	4.0	4.3	2.70	0.7	15	0.6	3.0	55°	✓				✓					✓								
ZYGEX	N/A	3.4	4.0	3.4	2.70	0.7	15	0.6	2.8	55°		✓	✓	✓	✓	✓	✓	✓	✓	✓	✓	✓	✓	✓	✓	✓	✓	✓

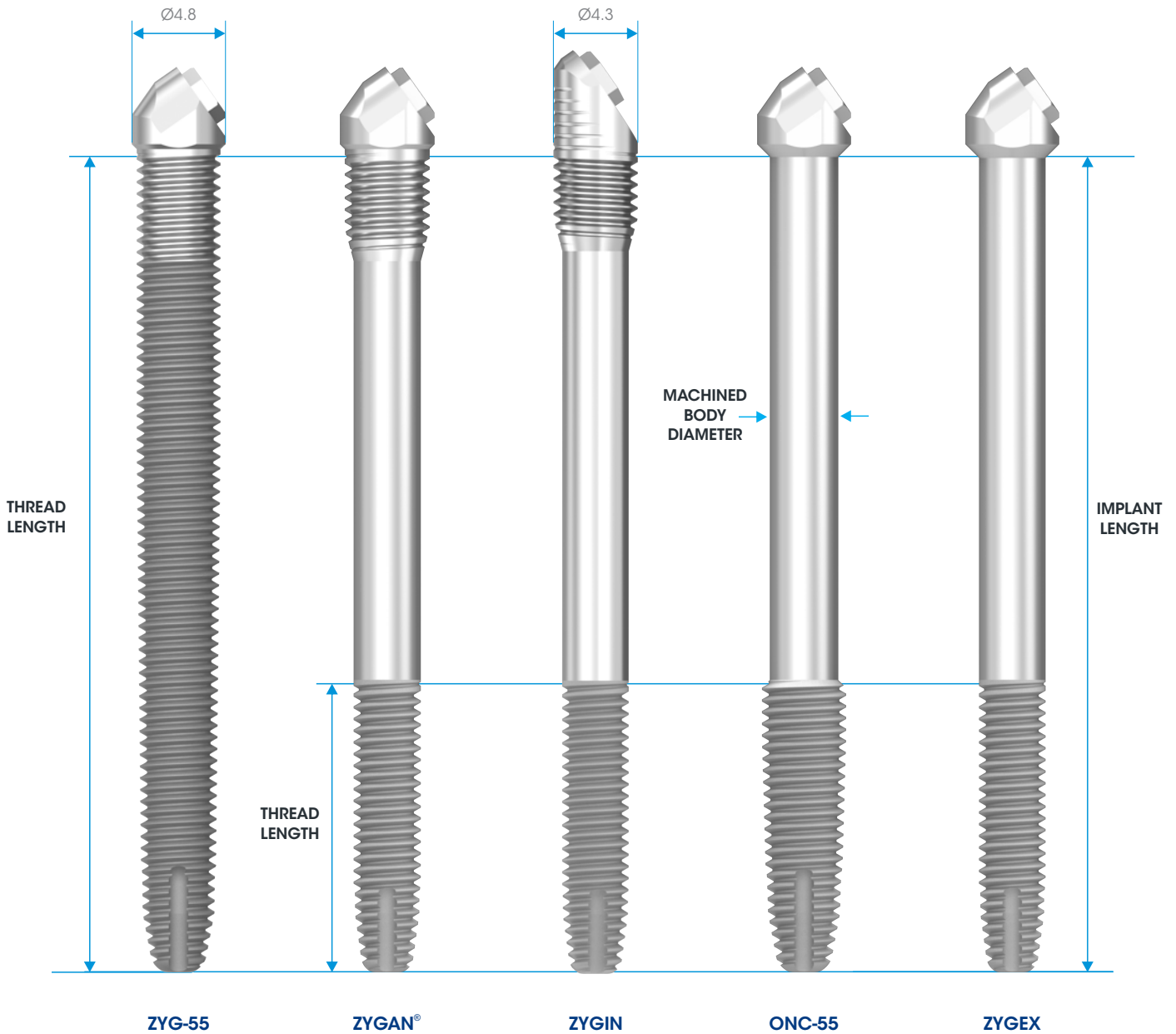

NOTE:

- all dimensions in this catalogue are in mm, unless otherwise specified.
- not all products are cleared for sale in all countries.

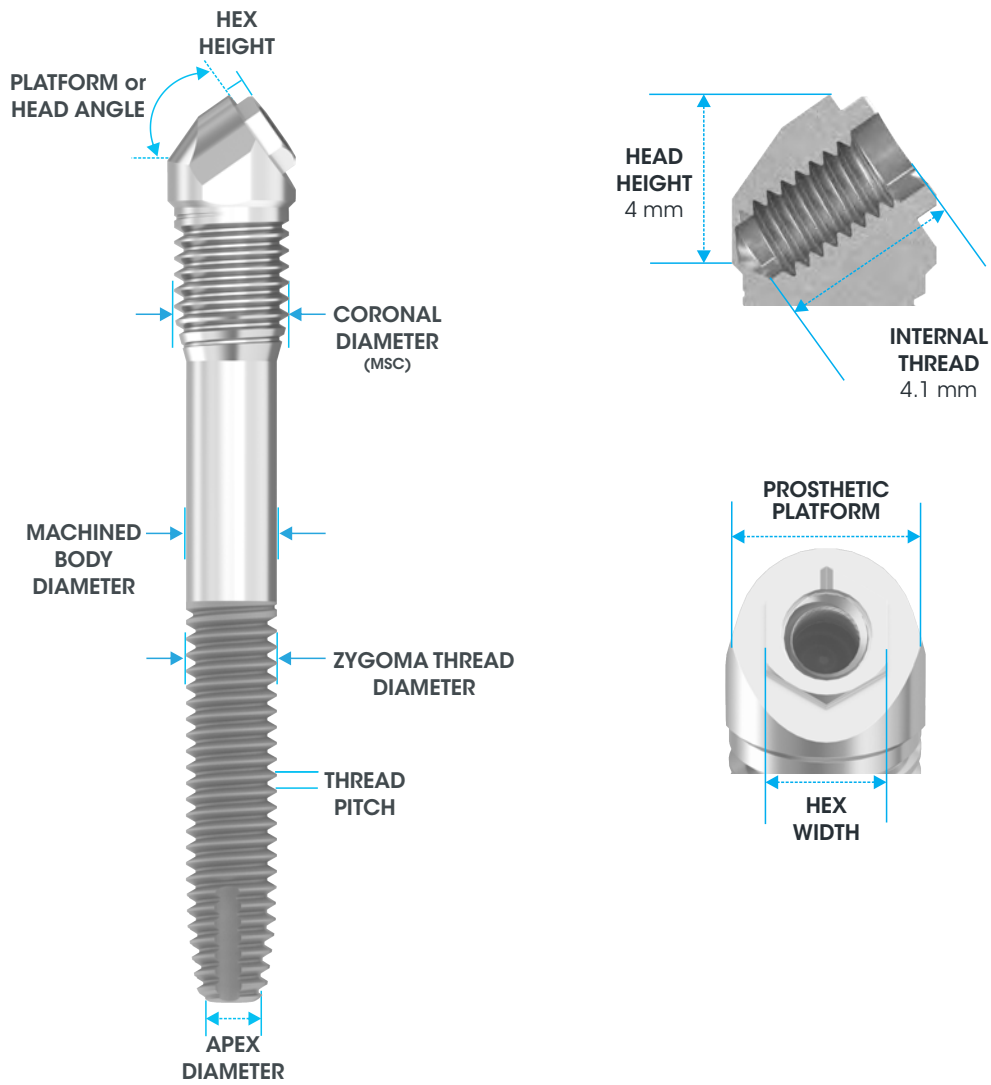

Instruments for implants packaged with a fixture mount

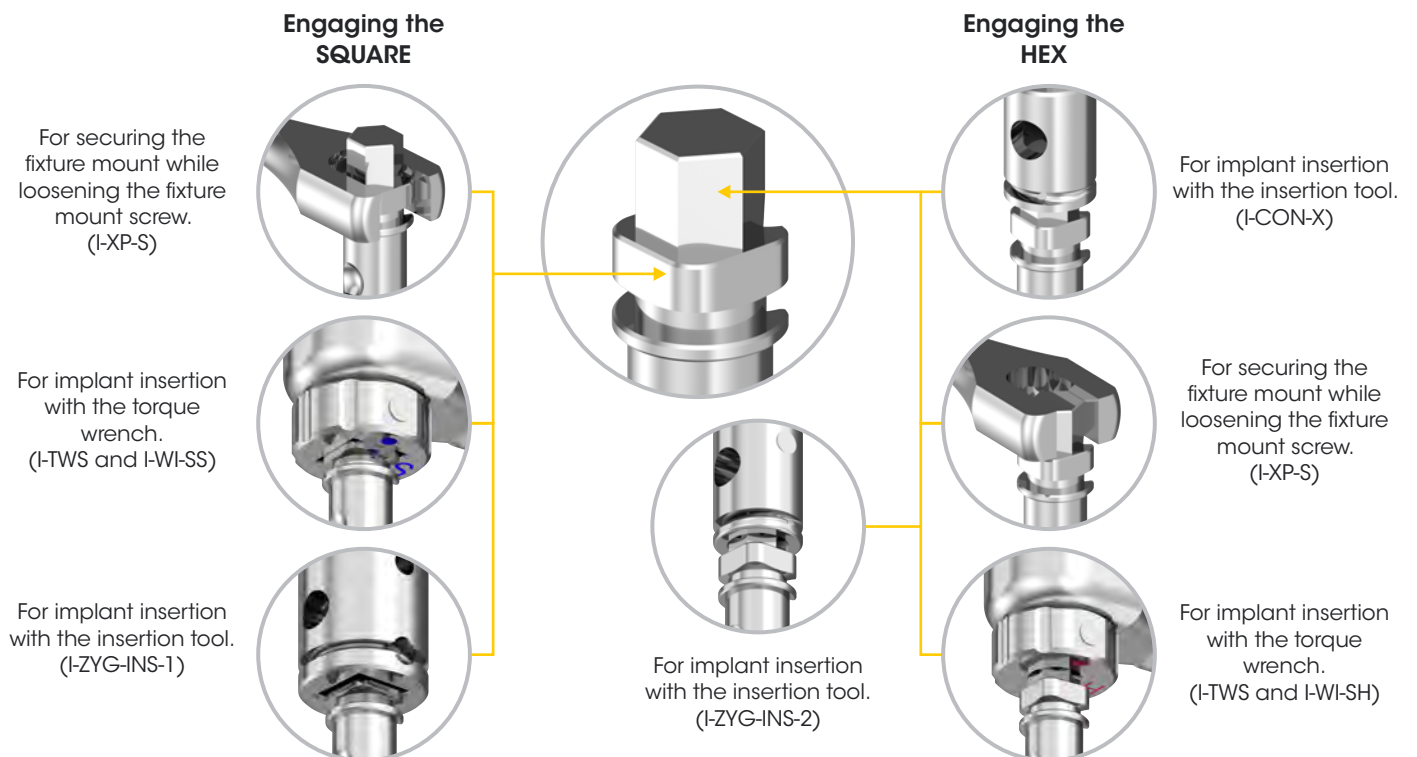

NOTE: for images of instruments illustrated here, refer to instrument tray pages (28 - 30).

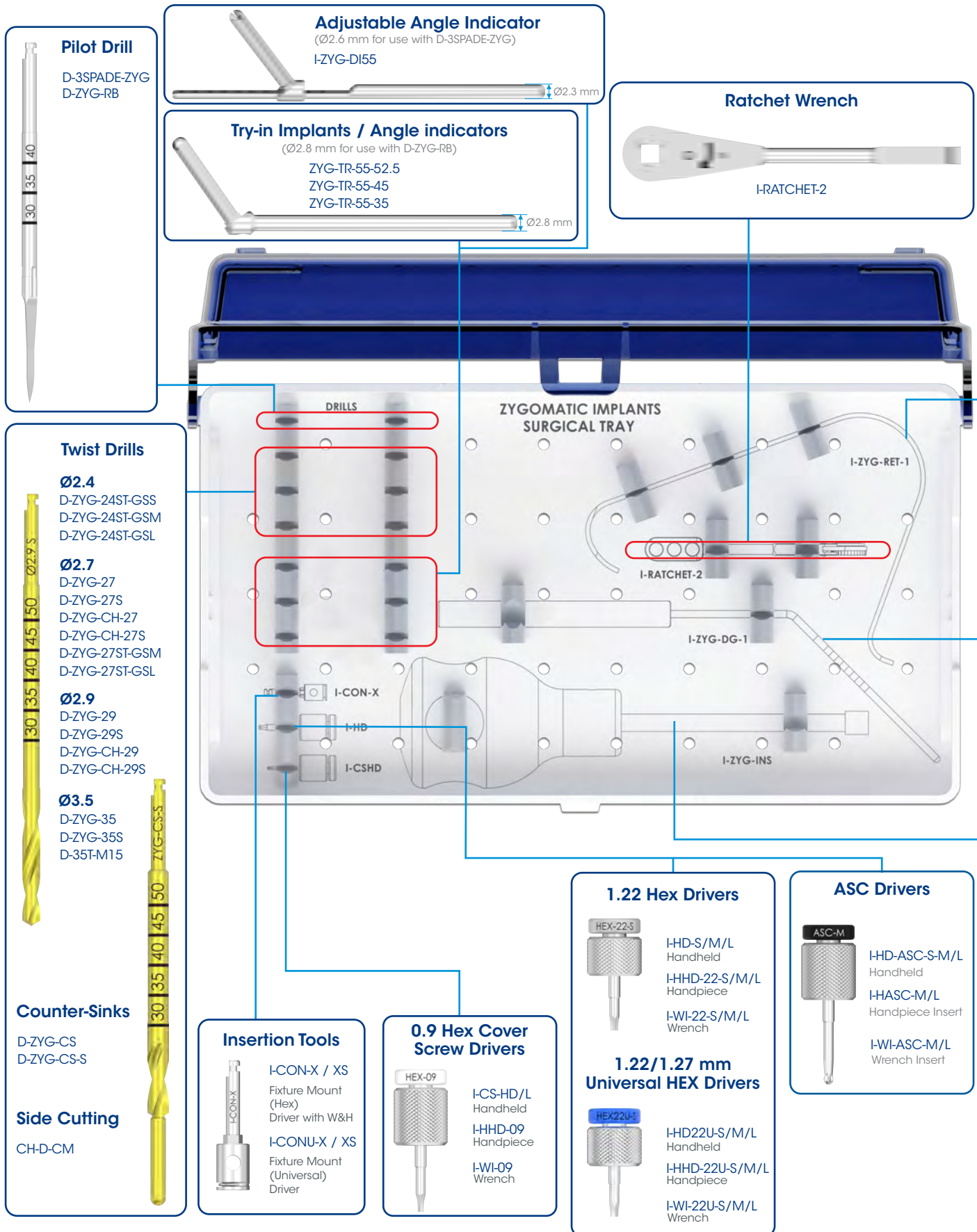

NOTE:

- the instrument kit has an intuitive layout to guide the surgeon through the drill sequence.
- most instruments are available in short / medium / long.
- all instruments and tooling used during the procedure must be maintained in good condition, cleaned and sterilised prior to use. Please consult the Instructions for Use: Southern Implants instrument tray and reusable instruments (CAT-8003 and CAT-8070) for guidance concerning the maintenance of instruments and surgical trays. Please consult the corresponding drill Instructions for Use regarding care and maintenance of drills.

Retractor

I-ZYG-RET-1



Depth Gauges

I-ZYG-DG-1



CH-DG

(Optional alternative instrument)

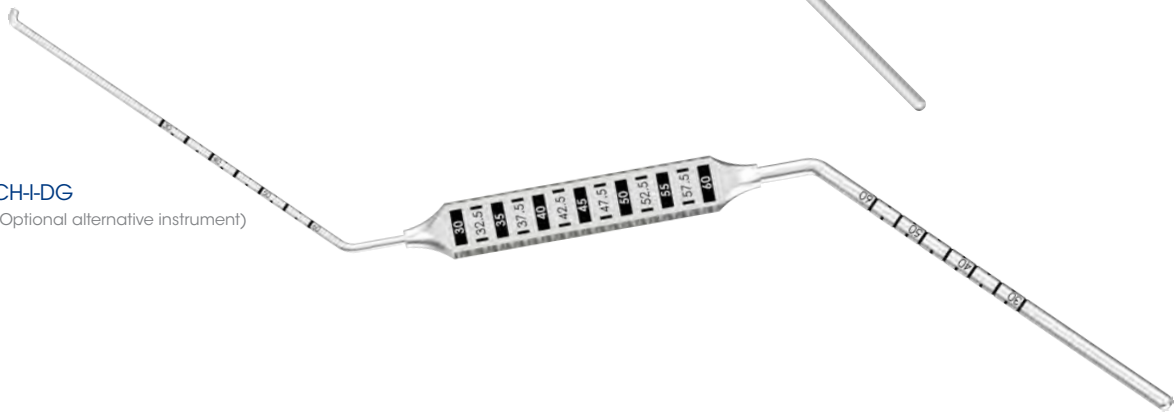

Insertion Tools

I-ZYG-INS-1

To fit square on fixture mount

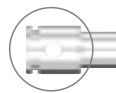

or

I-ZYG-INS-2

To fit hex on fixture mount

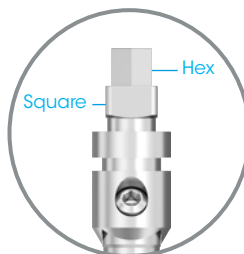
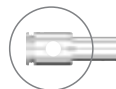

Square

Hex

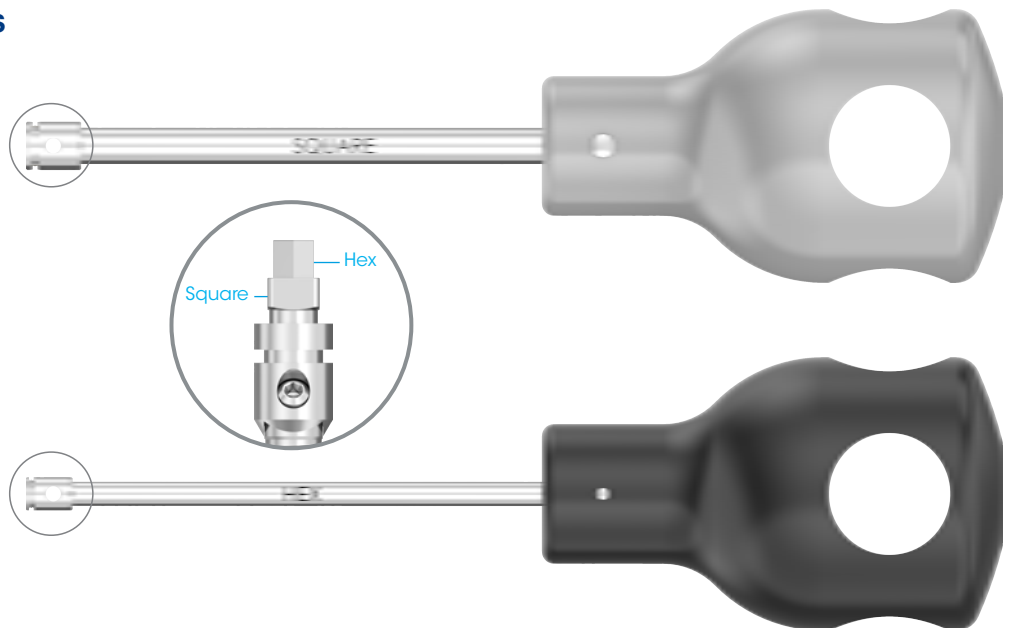

NOTE:

- I-ZYG-INS-1 drives on the square of the fixture mount (silver handle for easy identification).
- I-ZYG-INS-2 drives on the hex of the fixture mount. The narrow hex tip allows for more visibility of the implant head (black handle for easy identification).

TOP TRAY

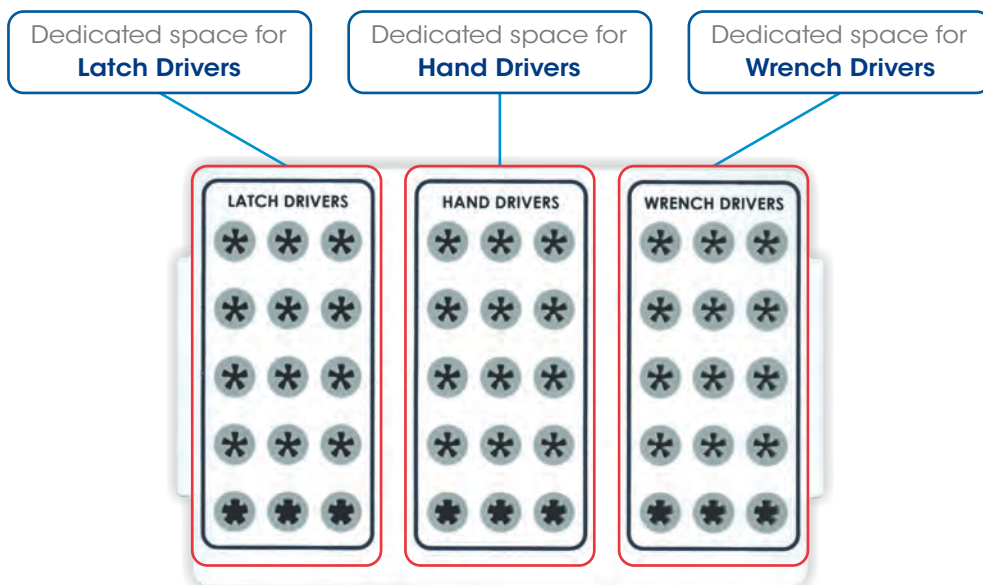

BOTTOM TRAY

Wrench Converters

- I-WI-CST**
For Handpiece inserts (latch-type) featuring the W&H hex.
- I-WI-SL**
For Handpiece inserts (latch-type) without the W&H hex.
- I-WI-SS**
For SQUARE connection of fixture mounts and instruments.
- I-WI-SH**
For HEX connection of fixture mounts.

Torque Attachments

- I-TWS-B45**
- I-TWS-B100**

Flat Spanner
I-SP-X (system specific)























Ratchet Wrench
I-TWS

NOTE:

- this instrument tray is to be customised by the user to be suitable for use with the preferred implant system and its surgical or prosthetic items.
- most instruments are available in various lengths.

EXPLANATION OF LABELING SYMBOLS

The following symbols are used on packaging labels and they indicate the following:

- 1  Manufacturer
- 2  Colour code indicating platform diameter
- 3  Implant image
- 4  Implant details and size
- 5  Sterilisation using Irradiation
-  European Representative
-  Catalogue number
-  Batch Code
-  Do not Resterilise
-  Consult instruction for use
-  Do not reuse
-  CE mark and notified body number
-  Use by Date
-  Date of manufacture
-  Do not use if package is damaged
-  Identifies the product as a medical device
-  MR Conditional / Magnetic Resonance Conditional
-  Single sterile barrier system
-  Double sterile barrier
- 6  2D Bar coding
Contains the GTIN, Use by date and LOT number
- 7  Patient sticker for documentation purposes
(to be used by health care provider on patient file)
- 8  Prescription device
CAUTION: FEDERAL LAW RESTRICTS THE DEVICE TO SALE BY OR ON THE ORDER OF A LICENCED HEALTH CARE PROVIDER.
- 9  Product description
(translated as per international standards)

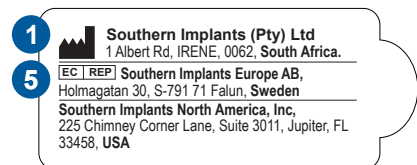
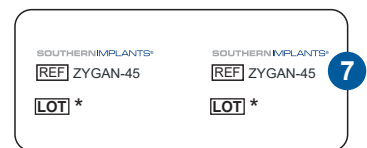
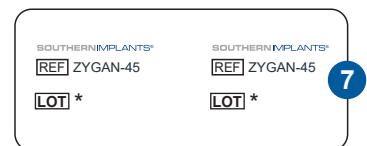
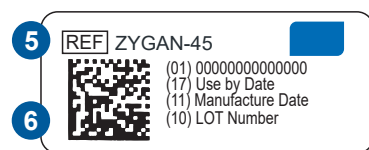
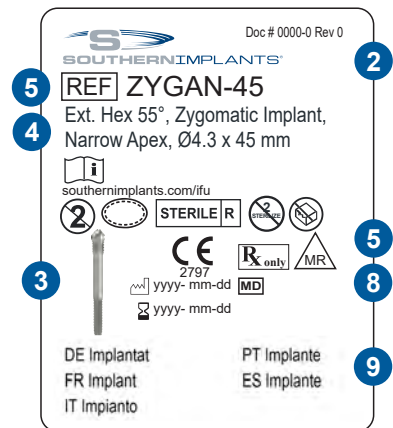

For more information on Instructions for Use of our products, please scan the below,



or visit our website
southernimplants.com/ifu

Platform Interface



For more information scan the below



to contact your Southern Implants Representative
or visit southernimplants.com



South Africa - Headquarters 1 Albert Road, Irene, RSA
T: +27-12-667-1046 | **E:** info@southernimplants.com

EC REP

Southern Implants Europe AB Holmgatan 30, S-791 71, Falun, Sweden
E: ecrep@southernimplants.com

Subsidiaries

Australia

Southern Implants Australia
T: +61-2-8076-9337
E: info@southernimplants.com.au

Spain and Portugal

Southern Implants Ibérica
T: +34 935 053 507
E: info@southernimplants.es

United Kingdom and Ireland

Southern Implants UK
T: +44-20-8899-6845 / 6 / 7
E: info@southernimplants.co.uk

USA and Canada

Southern Implants North America Inc.
T: +1-561-472-0990
E: customercare@southernimplants.com

**Southern Implants® are distributed world-wide, please visit southernimplants.com for a list of Distributors.
For the latest and full assortment of Southern Implant® products, visit our current resources library at southernimplants.com.**